

Chord Electronics
Product Communication | English

The Pumphouse, Farleigh Lane, East Farleigh, Kent,
ME16 9NB. Great Britain.
+44 (0) 1622 721 444
info@chordelectronics.co.uk
chordelectronics.co.uk

ULTIMA INTEGRATED Manual

V1.0



Chord Electronics Ltd.

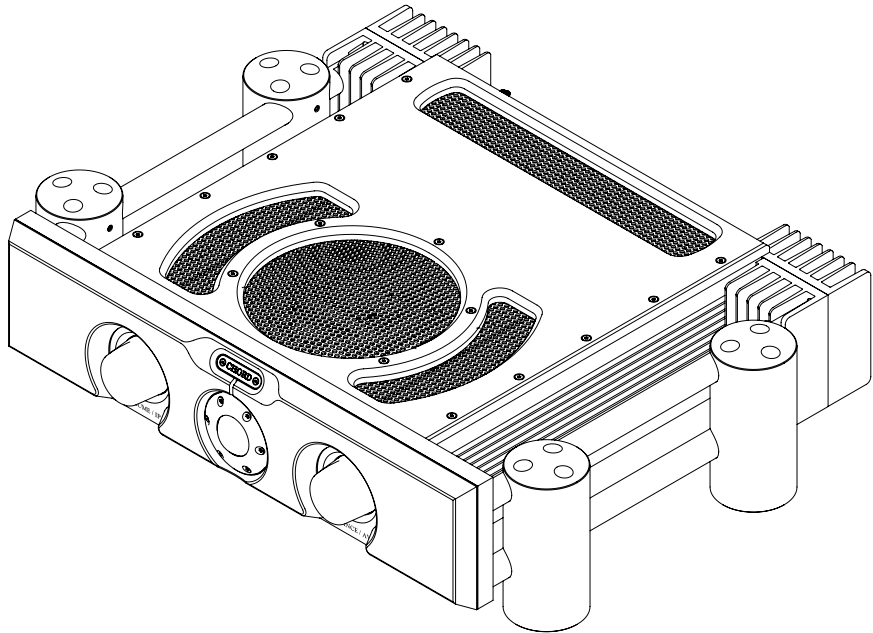

Made in
BRITAIN 

1 Contents

Introduction	2
Support and warranty	3
Connections and controls	4
Power connection	5
Inputs	6
Connecting to loudspeakers	7
Connecting to a power amp	8
Power on/off	9
Operation	10
12 V trigger	11
Placement	12
Technical specifications	13

2 Introduction

The ULTIMA INTEGRATED is a highly advanced 125-watt amplifier containing the very latest Chord Electronics ULTIMA circuit topology.

This manual provides all the information required to set up and operate the device, and further details can be found online at: chordelectronics.co.uk/ultima-integrated

2.1 Safety and care

- Do not allow the device to come into contact with water or liquids.
- Do not spray cleaning products onto the device. Use a clean microfibre cloth to clean the casework.
- A further safety document is included in the box.
- The device does not contain any user-serviceable components. Do not attempt to open, dismantle or apply internal third-party devices to it. Doing so will void the warranty.

3 Support and warranty

For support, please contact the supplying retailer before contacting Chord Electronics. Further help can be found at chordelectronics.co.uk/get-support



At the point of sale, Chord Electronics Ltd. provides the ULTIMA INTEGRATED with a comprehensive five-year warranty, which covers defects in materials and workmanship through fair usage.

The warranty is transferable with proof of purchase, however, the warranty on ex-demonstration units begins from the retailer's date of purchase. Warranty claims must be made via the supplying retailer.

For the best possible support and service, please register your purchase with Chord Electronics at: chordelectronics.co.uk/register-product/

4 Connections and controls

4.1 Rear and front panels

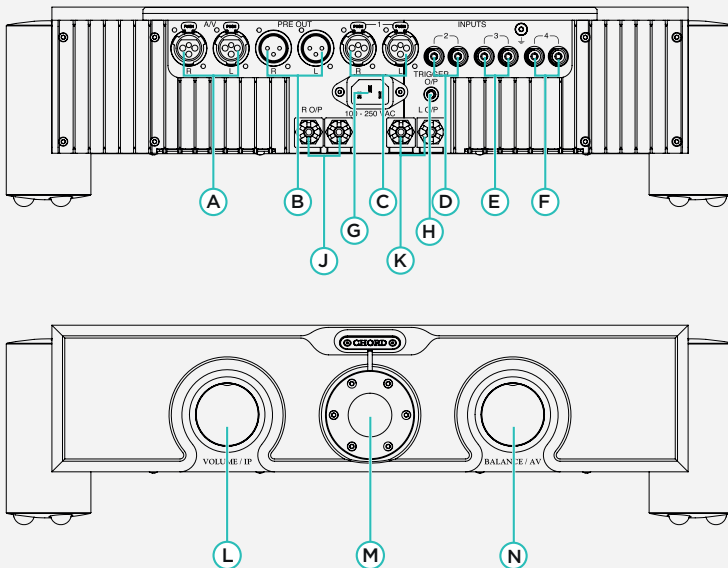

A	A/V bypass XLR inputs	B	Preamplifier XLR outputs	C	Line 1 XLR inputs
D	Line 2 RCA inputs	E	Line 3 RCA inputs	F	Line 4 RCA inputs
G	10 A IEC power inlet	H	12 V trigger connection	J	Loudspeaker terminals (right) *
K	Loudspeaker terminals (left)*	L	Volume control/input selector (combined)	M	Power button/status sphere
N	Balance control/AV bypass selector (combined)	* Please observe polarities			

WARNING: Ensure all system devices are switched off and any volumes are set to zero before making any connections.

4.2 Remote control

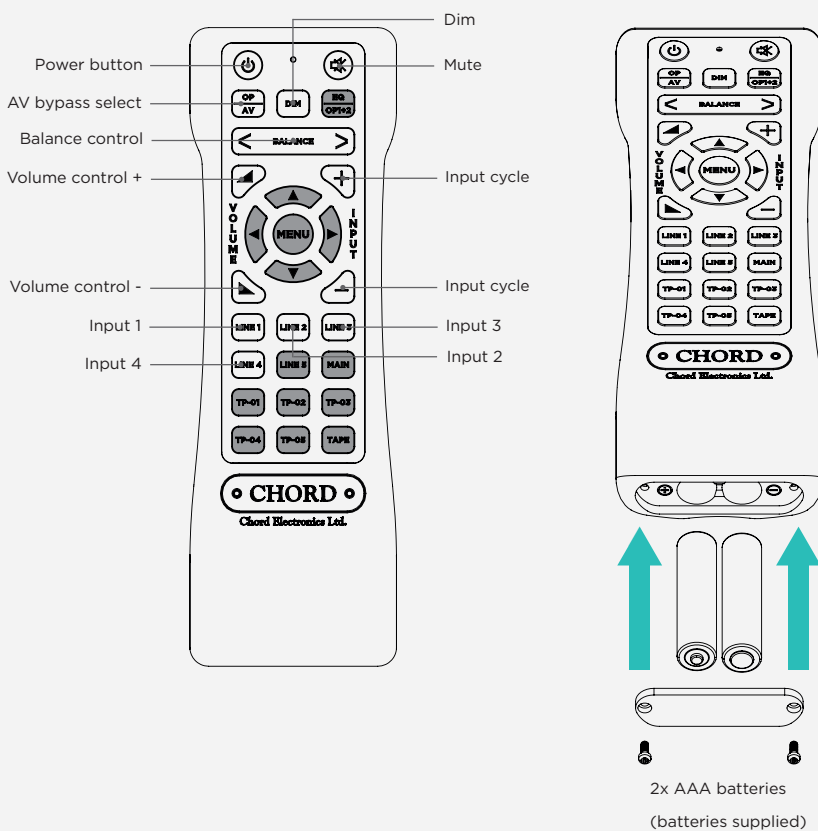

Note: greyed buttons are not functional on the ULTIMA INTEGRATED

5 Power connection

Connect the amplifier to power using the supplied 10 A power cable. If hum or buzz occurs, try using a good-quality (earthed) power distribution block

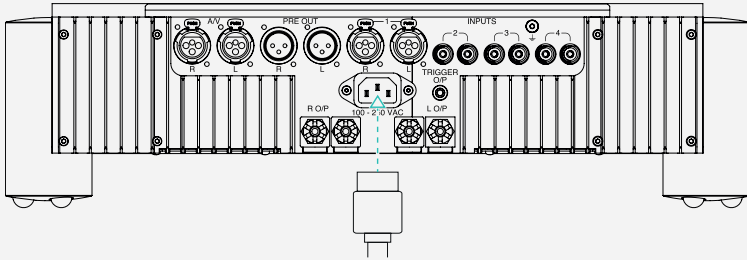

6 Inputs

Connect the amplifier to balanced source components using XLR input 1, observing R/L connectivity.

Connect the amplifier to unbalanced source components using RCA inputs 2-4, observing R/L (red/black) connections between the source and the amplifier.

Good-quality cables are recommended. For input selection see 'Operation'.

6.1 AV bypass

The AV bypass feature allows the output of an AV processor or receiver to directly connect to the amplifier's balanced AV input. The amplifier's volume control and signal processing are effectively bypassed, so that the signal from the connected AV device reaches the power amplifier section as if it were connected directly.

This can be useful for watching video where high-quality two-channel audio is desirable.

1) Connect the amplifier's balanced XLR AV bypass input (A/V) to the corresponding output on the partnering AV device.

2) Select the appropriate output on the connected AV device and ensure that AV bypass mode has been selected on the ULTIMA INTEGRATED, by pressing and holding the 'Balance/AV' control knob inwards (click) until purple is shown on the circular light ring. Pressing and holding a second time will exit AV bypass mode and the circular light ring will return to white.

7 Connecting to loudspeakers

Connect the amplifier to loudspeakers using good-quality loudspeaker cable, terminated with 4 mm banana plugs. Observe L and R channel, and black/red polarity is consistent at both the amplifier and loudspeaker end. If using spade plugs, unscrew the amplifier's loudspeaker terminals, connect the spades securely, and re-tighten the terminals. Although bare wire can be used, it is not recommended.

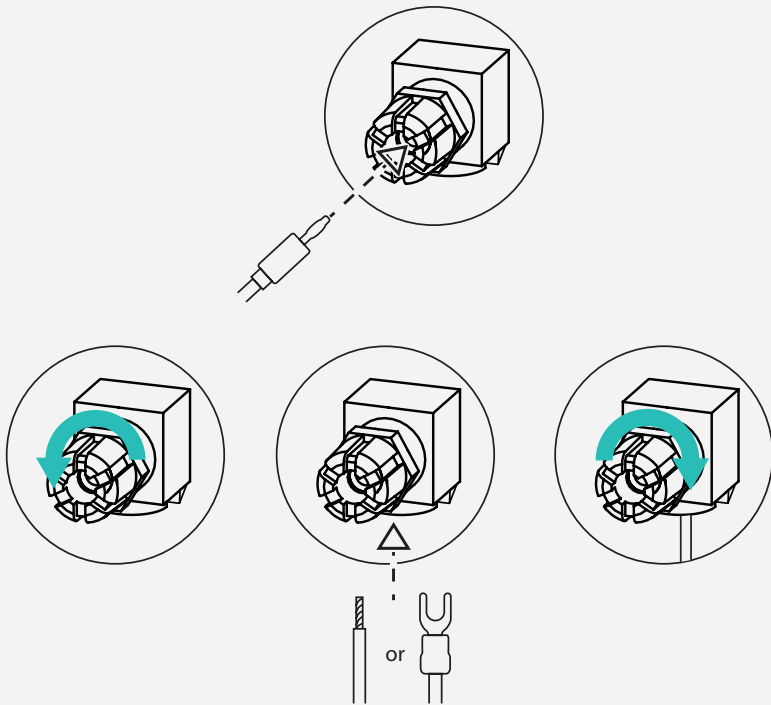

8 Connecting to a power amp

The ULTIMA INTEGRATED can be used as a preamplifier to provide a signal for another power amplifier if desired.

Connect the XLR PRE OUT 'R' to the right input on the corresponding power amplifier, and connect 'L' to the left input.

8.1 Bi-amping

The ULTIMA INTEGRATED can be used with an additional power amp to bi-amp compatible speakers. All Chord Electronics amplifiers are gain-matched, if you wish to use another manufacturer's power amp, ensure the gain matches the ULTIMA INTEGRATED.

Before bi-amping, power the system off and ensure the speaker terminal links are removed or damage to your speakers and amplifiers may occur.

When using an additional power amplifier, connect the XLR PRE OUT 'R' to the right input on the corresponding power amplifier, and connect XLR PRE OUT 'L' to the left input. From the ULTIMA INTEGRATED, run one pair of speaker cables to the high frequency inputs on the speakers (observing polarity). From any matching power amplifier run a second pair of speaker cables to the low frequency input on the speakers (observing polarity).

Note: the outputs from the ULTIMA INTEGRATED are always active. If in doubt please consult your retailer.

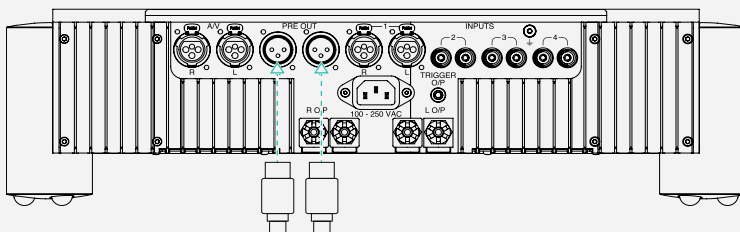

9 Power on/off

With all cable connections successfully made and the volume on the amplifier set to zero, press the front-panel power sphere to switch the amplifier on. The amplifier will perform a safety check and the sphere will change colour from red (standby), to green and then cyan (on), ready for use.

In standby mode, the ULTIMA INTEGRATED consumes very little energy (just 1 W) and, therefore, can be left in this mode at all times, if desired.

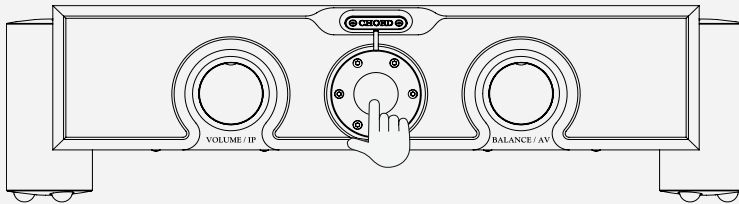

10 Operation

10.1 Input selection

Select between inputs 1-4 by pressing the front-panel volume/IP control inwards sequentially (click).

Input 1: (red)

Input 2: (yellow)

Input 3: (green)

Input 4: (blue)

10.2 Volume control

Volume can be adjusted using the front panel volume/IP control (rotate the knob clockwise/counter-clockwise).

10.3 Balance

Balance can be adjusted using the front panel balance/AV control (rotate the knob clockwise/counter-clockwise).

10.4 AV bypass

With all connections made as outlined in the AV bypass section, the AV bypass mode can be selected by pressing and holding the front panel balance/AV control inwards (click). The light colour will change from white to purple. Pressing and holding the button a second time will exit AV bypass mode and return the light to white.

Note: some operations, such as mute and dim (LED), are only accessible via the remote control; see 4.2.

12 V trigger

Partnering devices with a compatible 12 V trigger input can be connected with a suitable cable for simultaneous power on/off from standby mode. When connected the front panel button LED will turn yellow and once triggered the LED will change to purple.

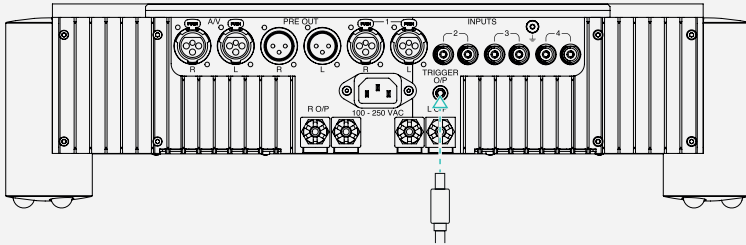

11 Placement

The amplifier benefits from extensive casework ventilation and heatsinking, however, care should be taken to ensure the device is used in a well-ventilated setting, away from direct sunlight and heat sources, with sufficient space (at least 10 cm) around the unit.

If stacking the amplifier with other units, it is advisable to place the unit atop others.

12 Technical Specifications

Please go to our website for the most recent specifications: www.chordelectronics.co.uk

Dimensions with Integra legs	13 cm (H) x 48 cm (W) x 38 cm (D)
Dimensions with side blocks	11 cm (H) x 43 cm (W) x 38 cm (D)
Frequency response	10 Hz-200 kHz +/- 3 dB
THD	0.01 % 20 Hz-20 kHz
Signal-to-noise ratio	90 dB on all inputs
Input impedance	100 k Ω
Input maximum voltage	Unbalanced: 3 V RMS Balanced: 6 V RMS
Output maximum voltage	35 V RMS
Gain	21 dB
Channel separation	100 dB
Operation voltage	80-250 V AC auto-switching
Power output	125 W into 8 Ω
Power consumption	(Idle/rated o/p) 45 W / 400 W (1 W standby)



Chord Electronics Ltd.

