

ULTIMA PRE 2

Manual

V.1.4



Chord Electronics Ltd.

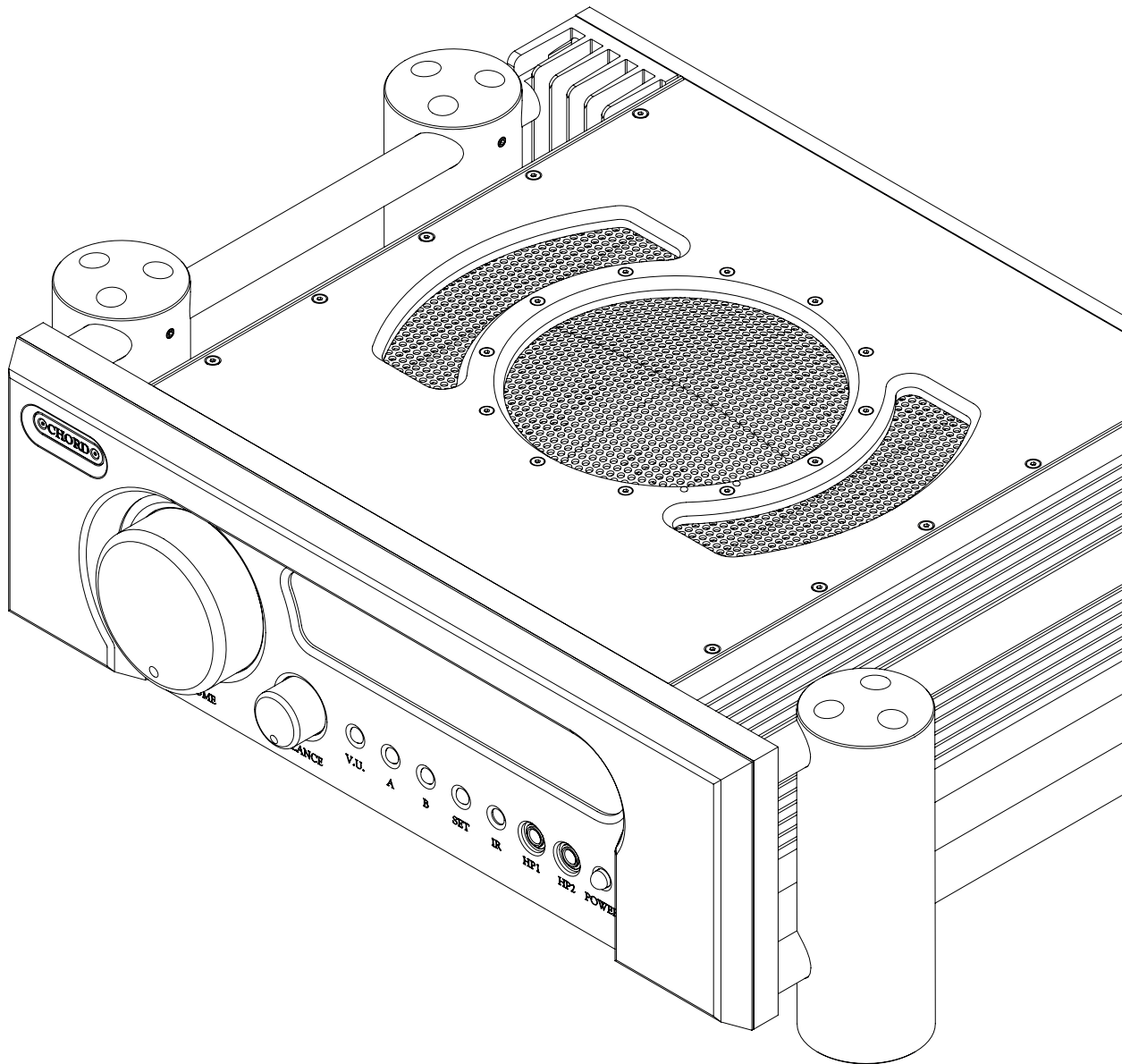

Contents

0.0

1.0 Safety instructions	03	2.0 Warranty	08
1.1 Introduction	04	2.1 Warranty period & registering your purchase	09
1.2 Protection against liquids & heat	05	2.2 Making a claim & warranty exclusions	10
1.3 Dismantling & Radio frequency interference	06		
1.4 Connecting your equipment	07		
3.0 Getting to know ULTIMA PRE 2	11	4.0 Setting up ULTIMA PRE 2	17
3.1 Getting to know ULTIMA PRE 2	12	4.1 Placement	18
3.2 The front panel	13	4.2 Connecting an input to ULTIMA PRE 2	19
3.3 The top panel	14	4.3 Connecting ULTIMA PRE 2 to a Power amplifier	20
3.4 The rear panel	15	4.4 Connecting ULTIMA PRE 2 to a recording device	21
3.5 The remote control	16	4.5 Connecting ULTIMA PRE 2 to a AV device	22
		4.6 Connecting ULTIMA PRE 2 to headphones	23
5.0 How to navigate the menu	24	6.0 Special features	31
5.1 Basic navigation	25	6.1 Gain	32
5.2 Volume and balance control	26		
5.3 Display	27		
5.4 Recording	29		
5.5 AV Bypass	30		

0.0

Contents

Safety instructions

1.0

- 1.1 Introduction
- 1.2 Protection against liquids & heat
- 1.3 Dismantling & Radio Frequency interference
- 1.4 Connecting your equipment

1.0 *Safety instructions*

Introduction

1.1



ULTIMA PRE 2 is flexible pre-amplifier featuring eight inputs, four stereo pairs of XLRs for balanced connections and another four RCA for unbalanced connections and a single stereo pair is available via XLR or RCA for outputs.

Before operation, we strongly advise you read this user manual thoroughly.

We also recommend that you store this user manual, along with your original receipt of purchase, in a safe place should you require assistance in the future.



 *Made in* **BRITAIN**

Protection against liquids & heat

1.2



ULTIMA PRE 2 is not protected against liquids of any kind. Never place containers of liquid on ULTIMA PRE 2. Never allow ULTIMA PRE 2 to come into contact with moisture or liquids; doing so could result in electrocution or damage to the ULTIMA PRE 2's internal circuitry.

Be aware that liquids, including water that has dried, can leave minerals that can affect the PCB and other components, which could eventually lead to oxidation and short-circuiting.

If the ULTIMA PRE 2 comes into contact with moisture or liquids, immediately disconnect from the mains power supply, and connected equipment and contact Chord Electronics for further advice.



The ULTIMA PRE 2 has internal thermal protection which will shut down the unit in the event of excessive temperatures being reached. Never operate the ULTIMA PRE 2 near sources of heat or naked flames as this will decrease the lifespan of the internal components. It is advised that you do not operate the ULTIMA PRE 2 in an area of direct sunlight or on top of significant heat-producing devices.

Please be aware that it is entirely normal for the ULTIMA PRE 2 to become warm during use, particularly within a stacked configuration. If you are concerned about the temperatures, please switch the device off or consider a different placement.

Dismantling & radio frequency interference

1.3



There are no user-serviceable components within the ULTIMA PRE 2 or its power supply. Dangerous voltages/currents exist within the ULTIMA PRE 2 and its power supply, posing a severe risk of electrocution and/or fire.



Never attempt to open, dismantle or apply internal third-party devices to it or insert anything other than the listed interconnects or headphone adapters within this user manual.

If the ULTIMA PRE 2 develops a fault or the casework becomes damaged, immediately disconnect from the mains power supply and connected equipment, and contact Chord Electronics for further advice.

With a thick, solid aluminium chassis, the ULTIMA PRE 2's casework largely protects the sensitive internal circuitry from radio frequency interference. However, for optimal performance, it is recommended that the following points are observed:



1. Consider placing the ULTIMA PRE 2 away from wireless routers.



2. Separate the ULTIMA PRE 2 from amplifiers using toroidal transformers.



3. Operate mobile phones at a distance to avoid interference.



Although the ULTIMA PRE 2 is largely shielded, it can generate radio frequency interference that may have an effect on radio and television reception. If this occurs, please reconsider your placement.

Connecting your equipment 1.4

Before connecting the ULTIMA PRE 2 to any equipment, consult the manufacturer's user guide to confirm compatibility.

When connecting the ULTIMA PRE 2 to any equipment, make sure that all devices are off, including the ULTIMA PRE 2.

Once connected, switch all equipment on starting with the source and ending with the amplification.

Initially, operate the any connected equipment on its lowest gain setting and lowest volume setting, gently increasing to a comfortable listening level.

Never operate connected equipment to the ULTIMA PRE 2 at excessive sound levels; permanent hearing damage and loss can occur.

The included 10 amp IEC mains lead plugs into the ULTIMA PRE 2.

If the power supply is prematurely disconnected ULTIMA PRE 2 may still remain active for up to 15 seconds, however, this may cause damage to connected equipment.



Never disconnect the power cable during operation. Only disconnect when ULTIMA PRE 2 is off. If the power cable is disconnected during operation there is a risk of damage to connected equipment.



Warranty

2.0

- 2.1 Warranty period & registering your purchase
- 2.2 Making a claim & warranty exclusions

2.0 *Warranty*

Warranty period & registering your purchase 2.1

At point of sale, Chord Electronics Ltd. provides ULTIMA PRE 2 with a comprehensive five-year warranty* which covers defects in materials and workmanship through fair wear and tear. The warranty will be void if any other PSU other than that supplied is used.

*The warranty is transferable with proof of purchase, however, warranty on ex-demonstration units begins from the retailer's date of purchase.



Please use the form below to record the details of your purchase in the event that these are required at a later date, we further advise that all purchases are registered with Chord Electronics at: chordelectronics.co.uk/register-product/



RETAILER:	
PURCHASE PRICE:	
UNIT COLOUR:	
DATE OF PURCHASE:	
TRANSACTION ID:	

Making a claim & warranty exclusions

2.2

In the unlikely event of a claim, you must provide Chord Electronics with the details of the claim, including your original proof of purchase and serial number in order to validate the nature of the repair.

Upon receipt, Chord Electronics will make an assessment within 30 days and provide a reasonable solution.

All warranty repairs must be carried out by Chord Electronics or an approved service centre to guarantee the quality and safety of the repair.

WARRANTY EXCLUSIONS: The warranty does not cover connected equipment, personal injury or development natural patina of the metalwork and will be null and void if the following is applied: wilful neglect; modification or tampering of the product; improper use of the product; acts of God; damage caused by a connected device; mechanical shock; fire or application of excessive heat or repair/modification by a non-authorised third-party vendor.

**Getting to know
ULTIMA PRE 2**

3.0

- 3.1 Getting to know ULTIMA PRE 2
- 3.2 The front panel
- 3.3 The top panel
- 3.4 The back panel
- 3.5 The remote control

3.0 *Getting to know
ULTIMA PRE 2*

Getting to know ULTIMA PRE 2 3.1

Featuring unrivalled connectivity and minimal colouration, the ULTIMA PRE 2 can be the hub of your Hi-Fi system without taking anything away from the incoming signal.

With a ability to connect up to 8 inputs, a AV bypass and several outputs, ULTIMA PRE 2 offers volume and balance control giving you full autonomy over your system. ULTIMA PRE 2 also has 2 recording output for your convinience.

To get the very most from the device we recommend that you familiarise yourself with the user manual.



The front panel

3.2

The front panel features the Display, Volume and Balance dials and the menu buttons. It also features the IR window which is used with the remote and 2 1/4 headphone jacks.

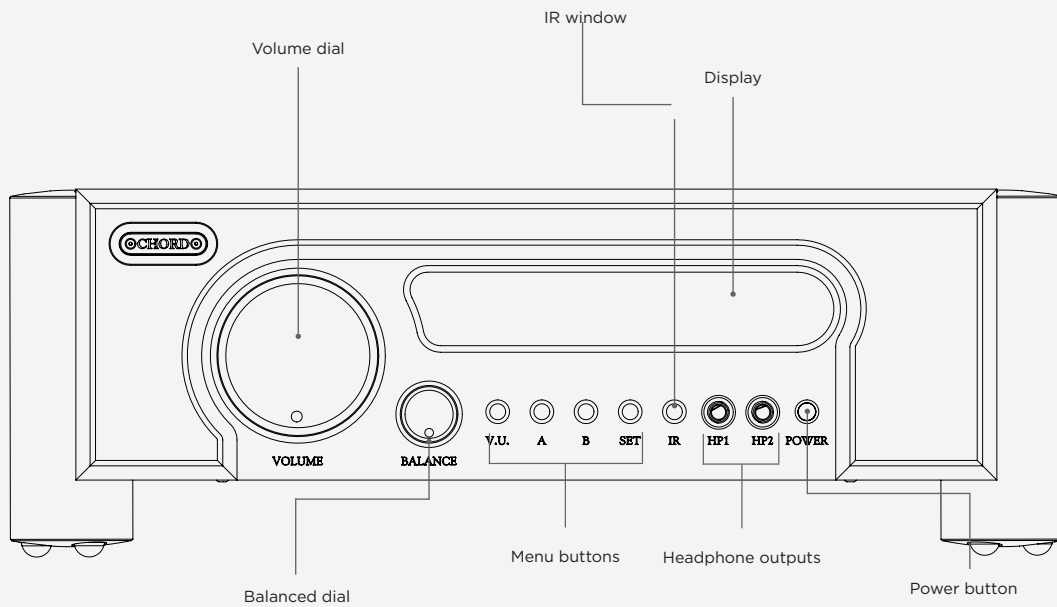

The top panel

3.3

The top panel has no user configurable options. Instead, three teal feature light rings illuminate.

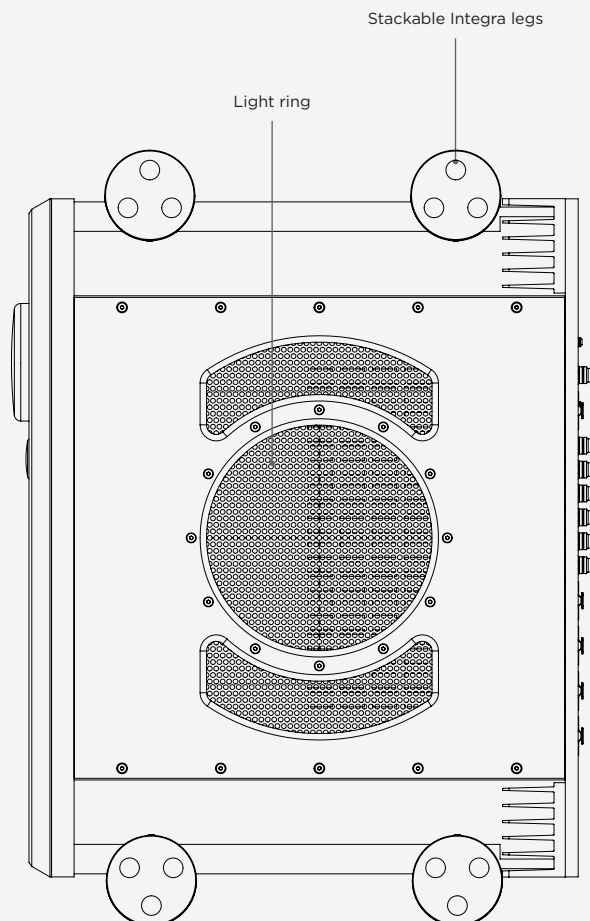

The rear panel

3.4

The rear panel houses the device's wide-ranging connectivity, inputs and outputs. The ULTIMA PRE 2 has several inputs and output allowing for high flexibility. Multiple inputs can be used all at the same time.

When installing any cable, you must make sure that they securely click into place.

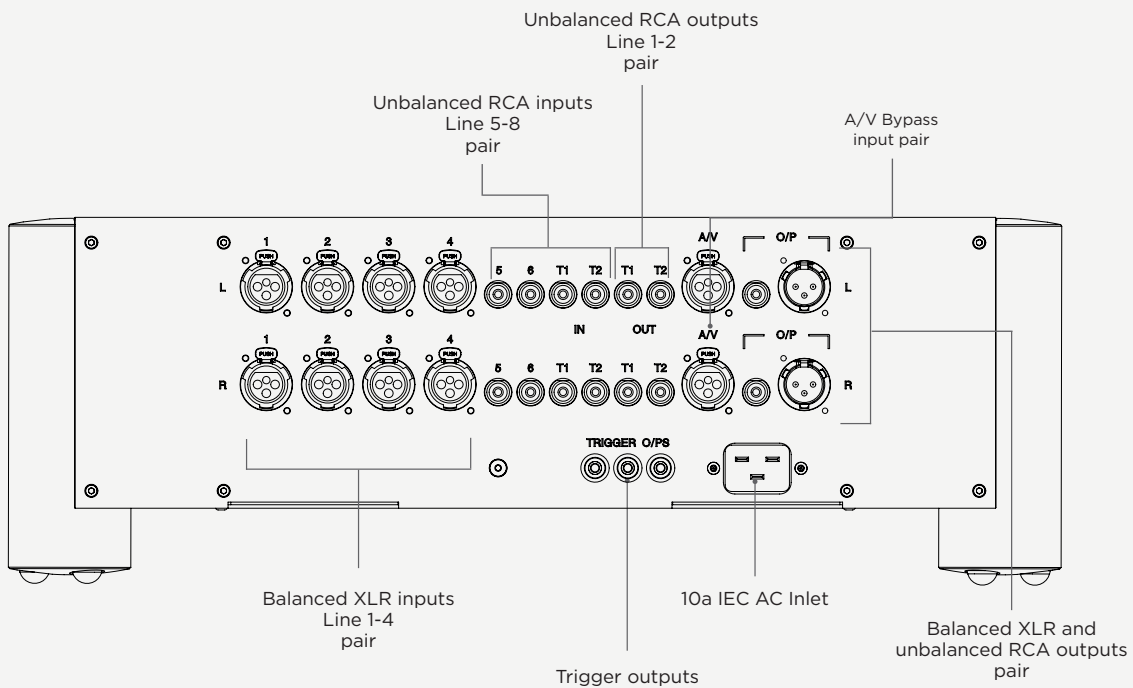

WARNING: Do not use any other power supply other than that supplied. Doing so will invalidate your warranty.

The remote control

3.5

The remote control gives you control over your full set up. The arrow section is reserved for DAVE.

Directly access line 1-5 inputs with the buttons at the bottom of the remote or to get 6-7 use the input cycle once the “Main” or “Tape” buttons are pressed.

Your selection on the remote will show on the ULTIMA PRE 2 display screen. As the infra-red remote control requires a direct line of sight to the viewing portal, please avoid placing objects in front of either device.

NOTE: The volume buttons will only work with ULTIMA PRE 2. To change inputs when DAVE is also in the system use the side buttons to change settings. Please see DAVE manual on using the remote control.

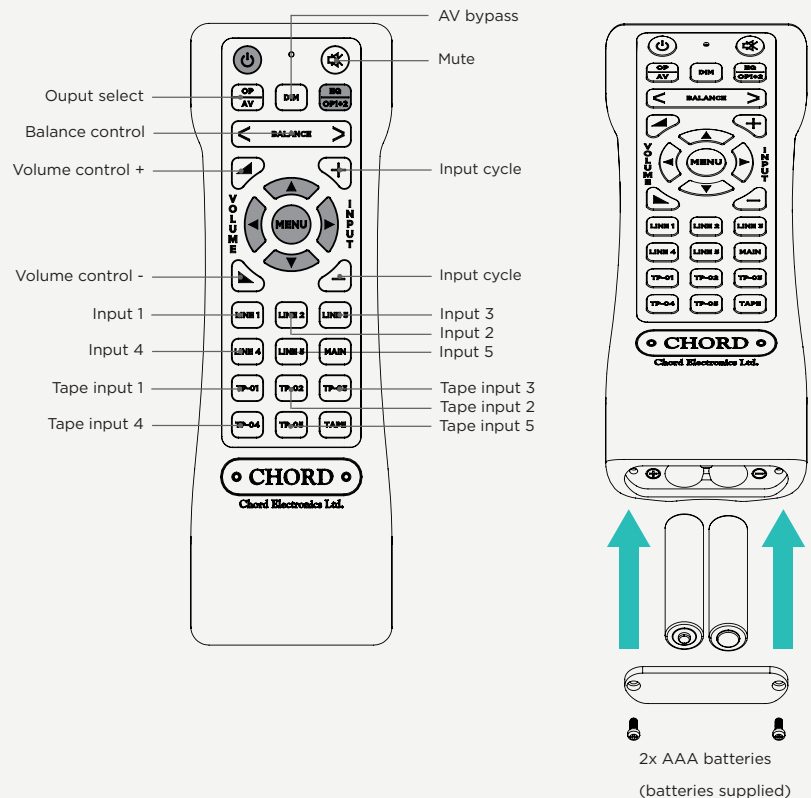

NOTE: Please only insert AAA batteries into the IR remote control and observe the correct orientation as indicated within the remote control. Failure to do so could result in non-operation or battery leakage.

Setting up ULTIMA PRE 2

4.0

- 4.1 Placement
- 4.2 Connecting an input to ULTIMA PRE 2
- 4.3 Connecting ULTIMA PRE 2 to a power amplifier
- 4.4 Connecting ULTIMA PRE 2 to a recording device
- 4.5 Connecting ULTIMA PRE 2 to a AV device
- 4.6 Connecting ULTIMA PRE 2 to headphones

4.0 *Setting up ULTIMA PRE 2*

- 4.1 Placement
- 4.2 Connecting an input to ULTIMA PRE 2
- 4.3 Connecting ULTIMA PRE 2 to a power amplifier
- 4.4 Connecting ULTIMA PRE 2 to a recording device
- 4.5 Connecting ULTIMA PRE 2 to a AV device
- 4.6 Connecting ULTIMA PRE 2 to headphones

Placement

4.1

Whilst the ULTIMA PRE 2 operates normally within a stack of other Full range products, it is recommended that you allow the device to breathe. Allocating 15cm of space around it to convection-cool during operation is advised. If possible, do not place the unit(s) inside a cabinet.

As the infra-red remote control requires a direct line of sight to the viewing portal, please avoid placing objects in front of either device.



Connecting an input to ULTIMA PRE 2

4.2

In order to connect up ULTIMA PRE 2 to a source, you must connect your cables to one of the inputs listed below. ULTIMA PRE 2 can have up to 8 inputs at once so it gives you the flexibility to fully curate your system with minimal effort required.

First, you must ensure that ULTIMA PRE 2, and any connecting equipment, is turned off.

For a balanced input use the double XLR inputs listed below.
For unbalanced inputs use the other 4 inputs listed below.

Please note that each input is arranged as a stereo pair, right and then left. Later, when you come to switch ULTIMA PRE 2 on, each pair of inputs will be shown as 'LINE X' on the display. LINE 1 begins the row of XLRs and LINE 5 begins the row of RCA.

It should be carefully noted that the pair of XLR, RCA, A/V and the right most T1 and T2 connectors next to the IEC input are outputs. You must not connect any inputs here.

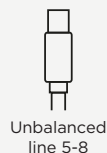
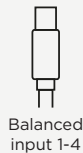
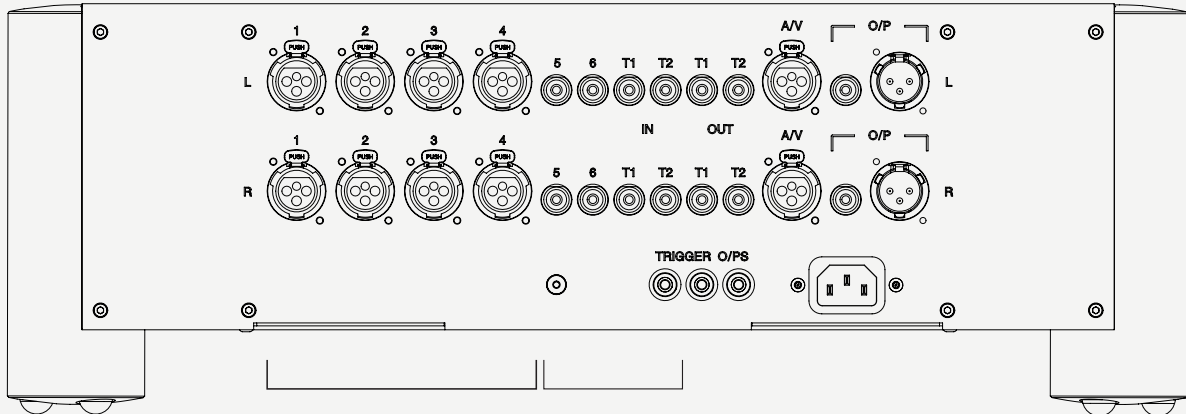

4.1	Placement	4.4	Connecting ULTIMA PRE 2 to a recording device
4.2	Connecting an input to ULTIMA PRE 2	4.5	Connecting ULTIMA PRE 2 to a AV device
4.3	Connecting ULTIMA PRE 2 to a power amplifier	4.6	Connecting ULTIMA PRE 2 to headphones

Connecting ULTIMA PRE 2 to a power amplifier 4.3

Using The XLR and RCA outputs shown below, it is simple to connect the ULTIMA PRE 2 to a power amplifier:

- 1) Turn off the ULTIMA PRE 2 and any other connected equipment.
- 2) Locate the XLR or RCA outputs on the ULTIMA PRE 2 and connect to the XLR or RCA input on the chosen power amplifier.
- 3) With the Volume set to the lowest setting Turn on all equipment, including the ULTIMA PRE 2.
- 4) Allow both the ULTIMA PRE 2 and power amplifier to power up.
- 5) Ensure the output mode is set to Output 1. If it is not check the cable is correctly connected.
- 5) With the Volume at the lowest setting initiate playback and gradually increase the volume to a comfortable setting to protect your hearing and speakers.

WARNING: Do not use the recording output to connect the ULTIMA PRE 2 to a power amplifier as it is a line level output and can not be attenuated!

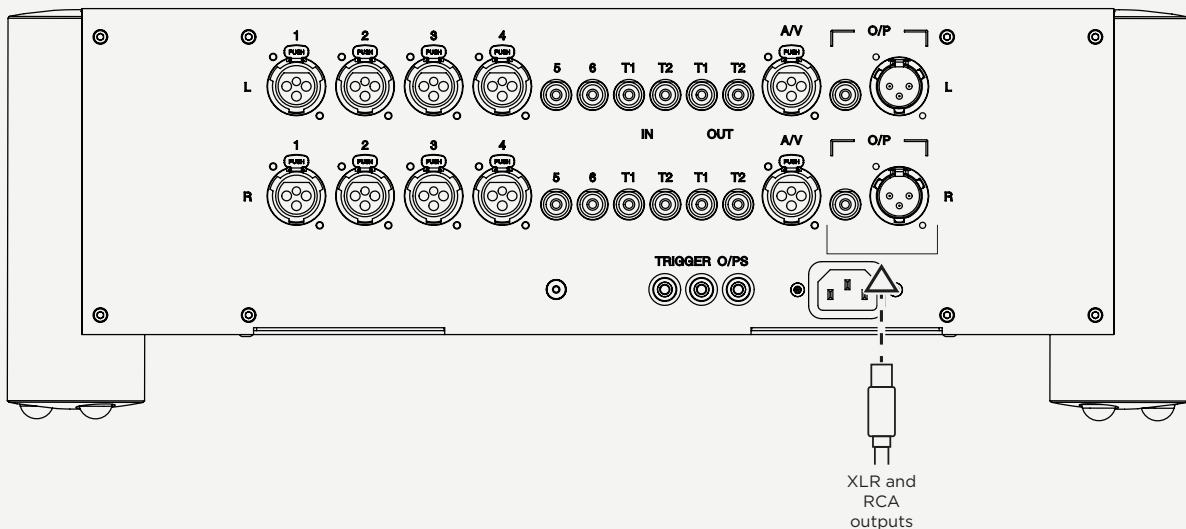

4.1	Placement	4.4	Connecting ULTIMA PRE 2 to a recording device
4.2	Connecting an input to ULTIMA PRE 2	4.5	Connecting ULTIMA PRE 2 to a AV device
4.3	Connecting ULTIMA PRE 2 to a power amplifier	4.6	Connecting ULTIMA PRE 2 to headphones

Connecting ULTIMA PRE 2 to a recording device 4.4

ULTIMA PRE 2 comes equipped with recording outputs. These are the two pairs of RCA connectors listed as the furthestmost T1 and T2. These RCA outputs are always live, at line level, and cannot be attenuated. Never connect an amplifier to these connectors! You can select the input to be passed through to the recording output via the dedicated button on the front of the device.

1) Turn off the ULTIMA PRE 2 and any other connected equipment.

- 2) Locate the RCA inputs shown below and connect your recording device with RCA cables.
- 3) With the Volume set to the lowest setting Turn on all equipment, including the ULTIMA PRE 2.
- 4) Select the appropriate input on the recording device.

5) With the Volume at the lowest setting initiate playback and gradually increase the volume to a comfortable setting to protect your hearing and devices.

Please view section 5.4 for more details on recording with ULTIMA PRE 2.

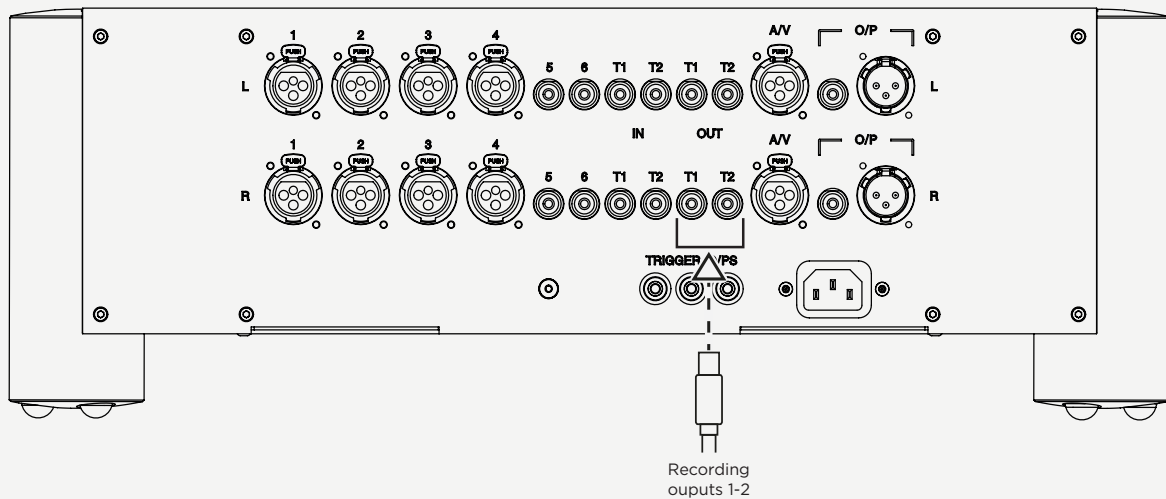

4.1	Placement	4.4	Connecting ULTIMA PRE 2 to a recording device
4.2	Connecting an input to ULTIMA PRE 2	4.5	Connecting ULTIMA PRE 2 to a AV device
4.3	Connecting ULTIMA PRE 2 to a power amplifier	4.6	Connecting ULTIMA PRE 2 to headphones

Connecting ULTIMA PRE 2 to a AV device 4.5

The ULTIMA PRE 2 comes equipt with an AV Bypass mode, allowing the output of an AV surround sound processor to be connected and then routed directly to the output. You may need this when switching from a 5.1 surround sound to a 2.0 set up for audio listening.

To set up with an AV unit;

- 1) Turn off the ULTIMA PRE 2 and any other connected equipment.

- 2) Locate the AV bypass inputs shown below and connect your device with XLR cables.
- 3) Connect up the power amplifier as shown in section 4.3.
- 4) Select the appropriate input on the AV device and ensure AV bypass mode has been selected on the ULTIMA PRE 2.

- 5) With the Volume a the lowest setting initiate playback and gradually increase the volume to a comfortable setting to protect your hearing and devices.

Please view section 5.5 for more details on using an AV device with ULTIMA PRE 2.

WARNING: The volume control in the ULTIMA PRE 2 will be bypassed so please check before switching on your AV processor that the volume is turned down.

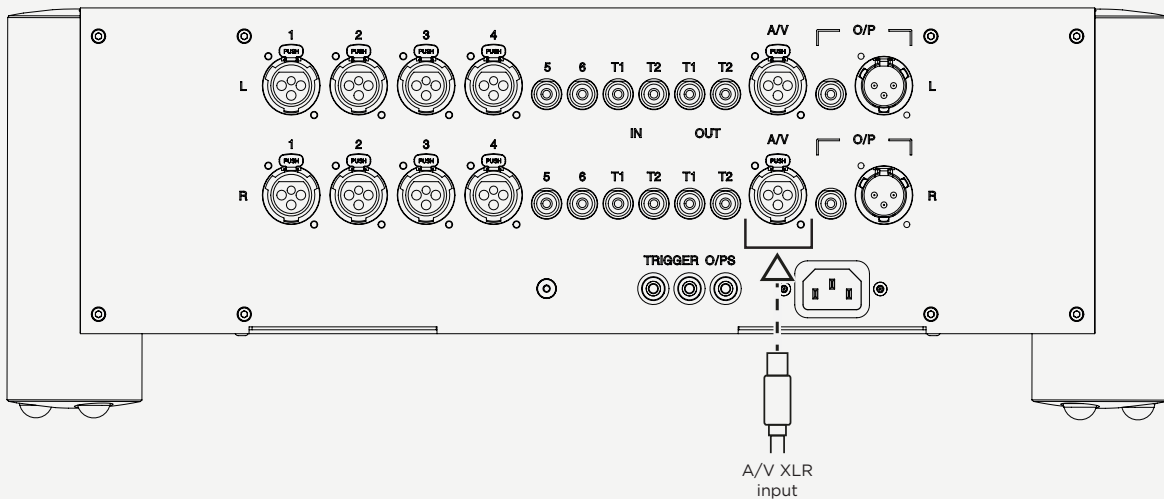

4.1	Placement	4.4	Connecting ULTIMA PRE 2 to a recording device
4.2	Connecting an input to ULTIMA PRE 2	4.5	Connecting ULTIMA PRE 2 to a AV device
4.3	Connecting ULTIMA PRE 2 to a power amplifier	4.6	Connecting ULTIMA PRE 2 to headphones

Connecting ULTIMA PRE 2 to headphones

4.6

If you want to use the Ultima Pre 2 with headphones, it features two 1/4 inch headphone sockets on the front panel. Headphone mode does not automatically mutes your loudspeakers. You must the amplification off.

- 1) Turn off the ULTIMA PRE 2 and any other connected equipment.
- 2) Locate the 1/4 inch headphone jacks on the front of the unit and plug in the jack. Use an adapter if needed.
- 3) With the Volume set to the lowest setting Turn on all equipment, including the ULTIMA PRE 2.
- 4) Allow both the ULTIMA PRE 2 and power amplifier to power up.
- 5) Ensure the output mode is set to Heapdphones. If it is not check the cable is corectly connected.
- 6) With the Volume a the lowest setting initiate playback and gradually increase the volume to a comfortable setting to protect your hearing and headphones.

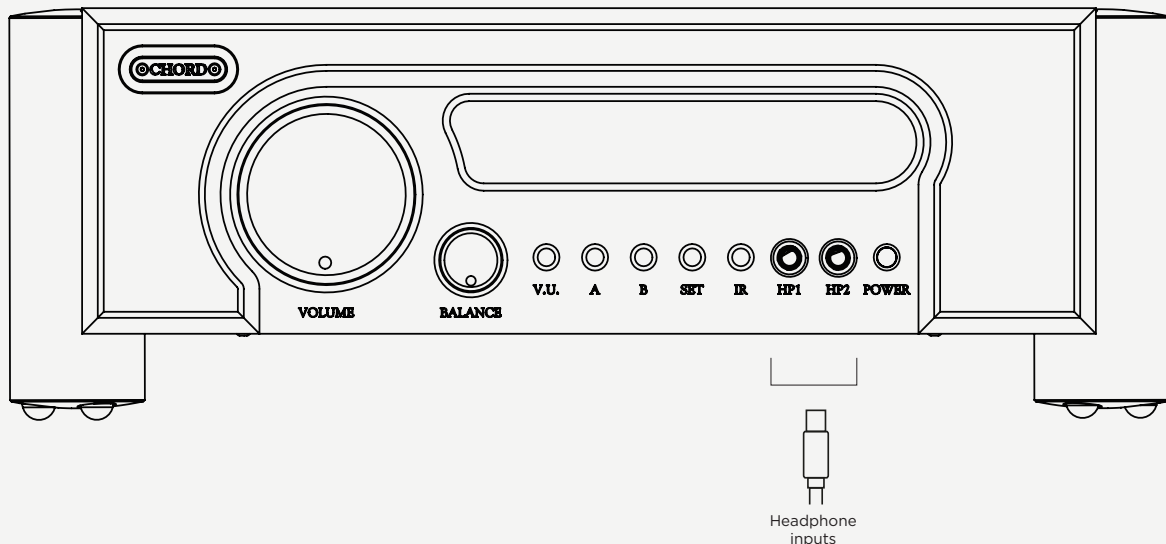

How to navigate the menu 5.0

- 5.1 Basic navigation
- 5.2 Volume and balance control
- 5.3 Display
- 5.4 Recording
- 5.5 AV Bypass

5.0 *How to navigate the menu*

Basic navigation

5.1

In order to use the ULTIME PRE 2 you can either use the buttons on the front of the unit or the remote control to navigate the menu.

V.U: The V.U button can be used when you'd like to change the view of the Volume Unit on the display screen.

Button A: The A button can be used to select Main Bus. Press several times to select your desired input. ULTIME PRE 2 will remember this setting. Your ULTIME PRE 2 should be set to Main Bus for normal operation. The selected input will automatically be sent to the recording T1 phono outputs. View section 5.3 for further details.

Button B: The B button can be used to select Tape Bus. Press the B button several times to choose your input. This will be displayed with dots under the input to indicate it is Tape Bus. The selected input will automatically be sent to the recording T2 phono outputs. View section 5.3 for further details.

Set button: The set button will allow you to select an output. Press the button several times to select the right output. View section 5.3 for further details.

Alternatively you can use the lower buttons on the ULTIME PRE 2 remote to select the correct input and output. The left hand side is for Main Bus and right hand side is for Tape Bus.

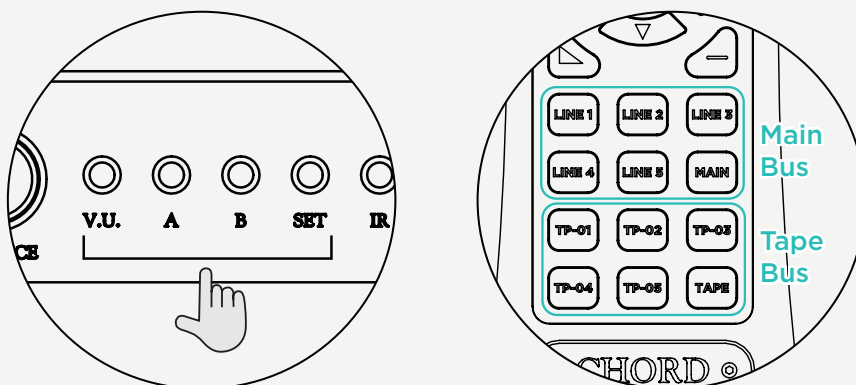

Volume and balance control 5.2

On your source commence playback and, using the left-hand dial, slowly increase the volume of ULTIMA PRE 2, to a safe listening level.

The volume range runs from 0 to 98 and is displayed on the ULTIMA PRE 2 as you alter the volume. If the outputs are muted, a volume change will un-mute the outputs to prevent large changes in volume from damaging your loudspeakers.

The dial on the right adjusts balance. Typically, this should remain in the centre of its rotation for balanced sound between the left and right outputs.

Use the balance dial to shift the balance between the left and right loudspeaker. A clockwise turn of the knob will shift the balance to the right speaker and an anti-clockwise turn of the knob will shift the balance to the left speaker.

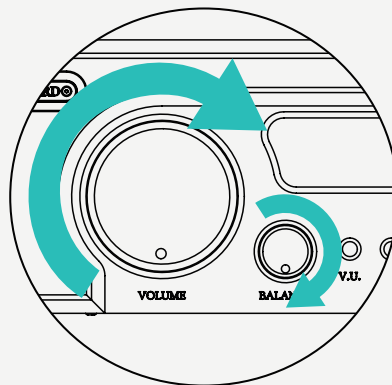

Display

5.3

Main Bus selection: To assign the main output with a particular input signal, press the A button several times to cycle through the 7 line inputs until, the display shows the input you wish to use. The options are shown in the diagram below;

Tape Bus selection: To assign an additional output to Tape Bus with a particular input signal, press the B button several times to cycle through the 7 line inputs until, the display shows the input you wish to use. Note that the inputs will display with lines underneath to indicate it is Tape Bus. The options are shown in the diagram below;

Output selection: To select the output press the set button several times to cycle through the 4 outputs listed. Please note that both XLR and RCA outputs will be live at the same time and will both be listed as Out-1. The options are shown in the diagram below;

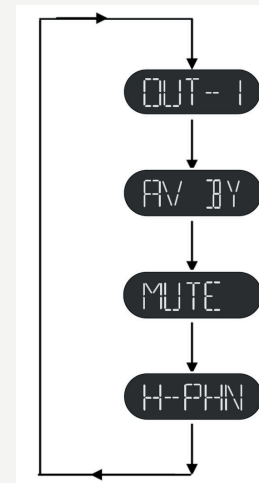
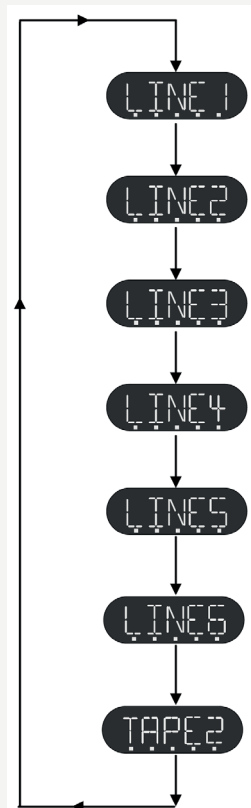
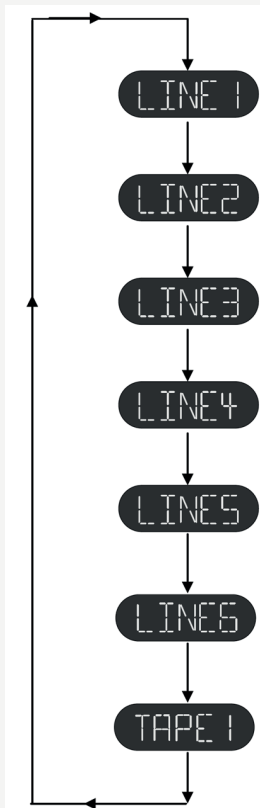

Display

5.3

Volume: Use the volume knob to adjust the volume manually. A clockwise turn of the knob will increase the volume and an anti-clockwise turn of the knob will decrease the volume. The volume range runs from 0 to 98 and is displayed on the ULTIMA PRE 2 as you alter the volume. If the outputs are muted, a volume change will un-mute the outputs to prevent large changes in volume from damaging your loudspeakers. An example is display below;



Recording

5.4

You can record an input from another audio source or two sources at the same time. To do so first connect the recording device's output to the T1 or T2 input (IN) sockets.

Your amplifier has two input selection buses. The default bus is Main Bus and this is the one you would use to choose your inputs in everyday operation. The advantage of having two buses is that it allows for two recording devices to record (different inputs) simultaneously.

Main Bus is permanently connected to the Tape 1 (T1) output and Tape Bus is permanently connected to Tape 2 (T2) output.

You can record from any source to either of the recording outputs and both outputs can be monitored.

You can play audio on Line 1 on Main Bus and record this by connecting your recording device to the Tape 1 (T1) output. At the same time you can play another audio device on Line 2 and connect another recording device to the Tape 2 (T2) output to record it. Simply switch between Main Bus and Tape Bus to monitor either of the sources.

If you are recording an input on one Bus you can still listen to another input whilst recording simply by selecting the other bus.

AV Bypass

5.5

AV Bypass mode allows the output of an AV surround sound processor to be connected and then routed directly to the output of the ULTIMA PRE 2. The volume control and signal processing are bypassed so that the signal from the AV processor reaches the power amplifier exactly as if it were connected directly.

This has the advantage of allowing the ULTIMA PRE 2 to remain in an AV system to give the best possible stereo two channel playback whilst still being able to switch to AV bypass mode to allow the processor to playback multichannel film content.

Note: The volume control in the ULTIMA PRE 2 will be bypassed so please check before switching on your AV processor that the volume is turned down. When switching back please check that the volume on the Ultima Pre 2 has not inadvertently been turned up before playing any music.

Special features

6.0

6.1 Gain

6.0 *Special features*

Gain

6.1

You can adjust the input gain on you input devices so that you can align the volume levels of your different inputs. There are six settings, which are x0.50, x1.00, x1.50, x2.00, x2.50 and x3.00.

Gain on Main Bus inputs: Select your desired input on the remote control and then press MAIN. The display will show the currently selected gain for this input. Press the VOL + to increase gain or VOL - to decrease.

Gain on Tape Bus inputs: Select your desired input on the remote control and then press TAPE. The display will show the currently selected gain for this input. Press the VOL + to increase gain or VOL - to decrease.

Gain display: Once you have adjusted the gain setting on an input device your amplifier will remember the setting on booting up the system in the future. The six available gain settings are shown below as they are displayed on the ULTIMA PRE 2.



NOTE: When using a Chord Electronics DAC please set the line gain to 0.5.



Chord Electronics Ltd.

